

# ENAR TAX SHAFT ASSEMBLY 5 METRE To Suit Enar 38, 48, & 58mm Heads

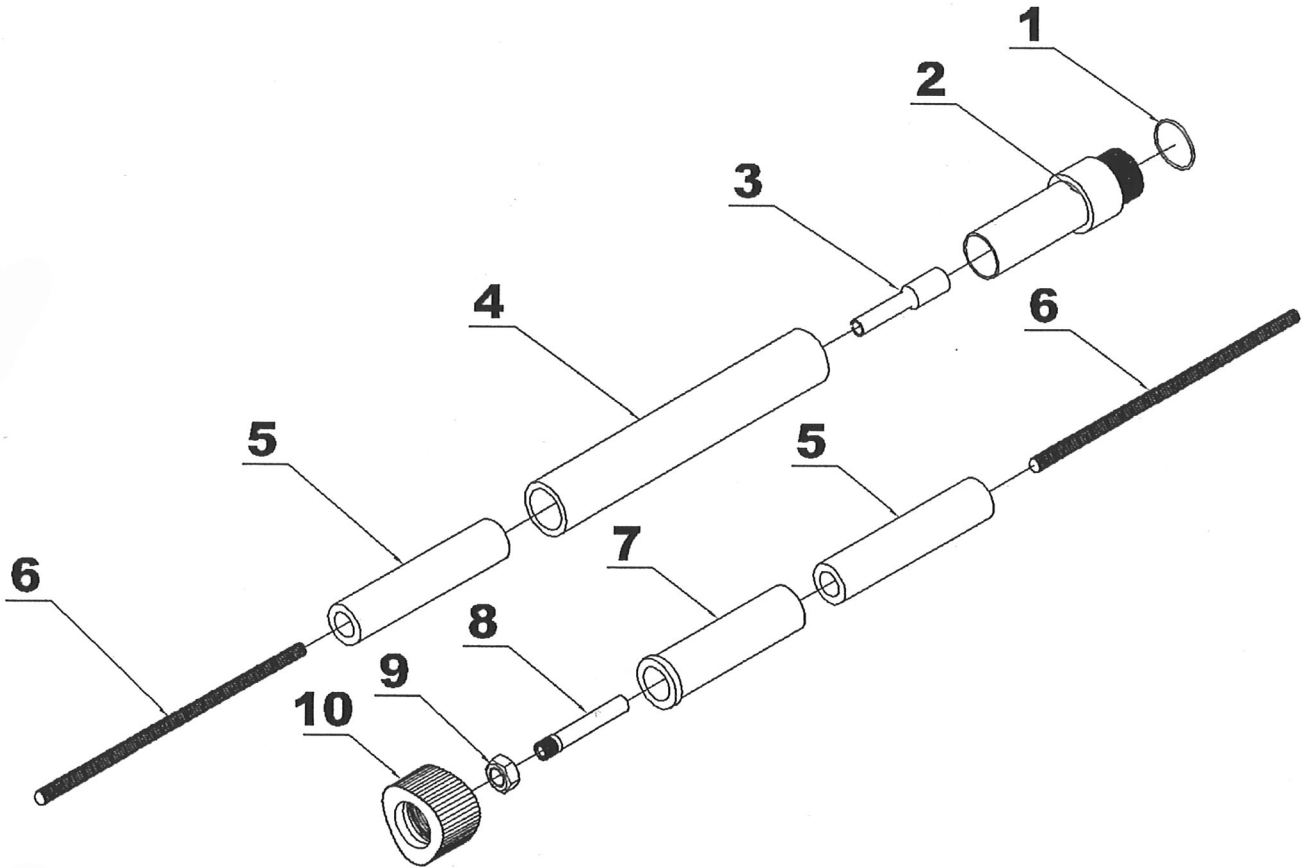

	Number	Quantity	Description
1	101826	1	O RING 29.5 x 1.5
2	96501	1	POKER HOSE JOINT
3	96510	1	POKER SHAFT JOINT
4	122064	1	RUBBER REINFORCEMENT (Not replaceable)
5	96401	1	HOSE 5m
6	96402	1	INNER CORE (Does not have 96510 or 96523 fitted)
7	96502	1	MOTOR HOSE JOINT
8	96523	1	MOTOR CONNECTION
9	102215	1	NUT HEX. M11 x 1 DIN 934 8.8
10	96512	1	NUT



**Concrete Tool  
Importers Ltd**